

CBP90 Series Tri-Barrier Strip Terminal Blocks

Pitch : 9.5mm

Poles : 2P~32P

Electrical Rating	15A 300VAC
Housing Material	PA66, Black
Terminal	Brass, 0.8t Tin Plated
Screw	Steel, M3.5, Nickel Plated
Working Temperature	-40°C to +105°C
Insulation withstand Voltage	AC2000V at 1 min
Insulation resistance	500MΩ or more at DC 500V
Wire Range	22~12 AWG
Max. Torque Value	12Kg/cm

Unit : mm

CBP90-01

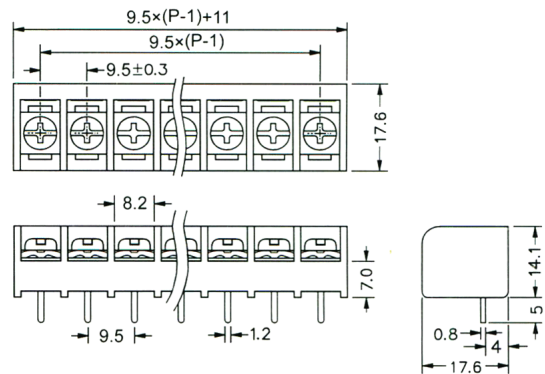
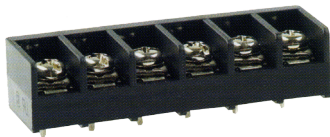

CBP90-02

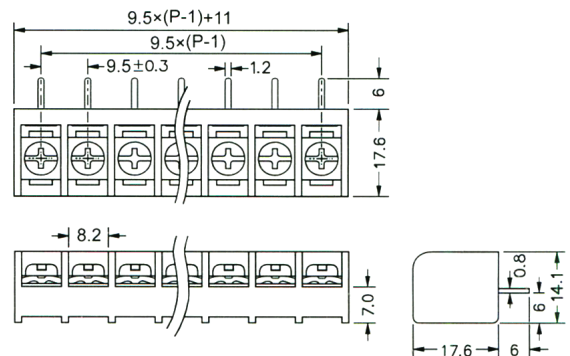
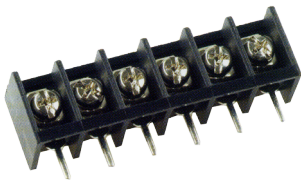

CBP90-03

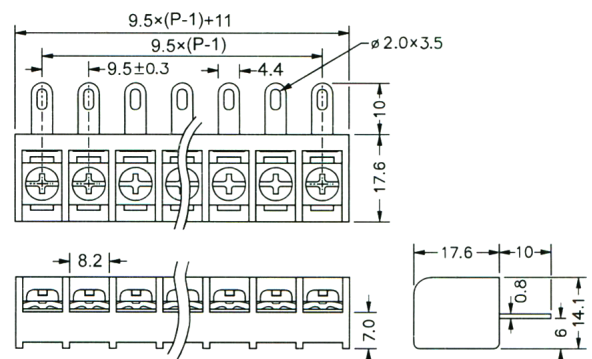
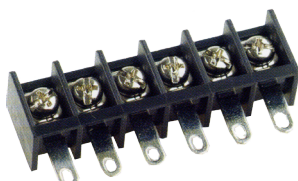

Unit : mm

CBP90-04

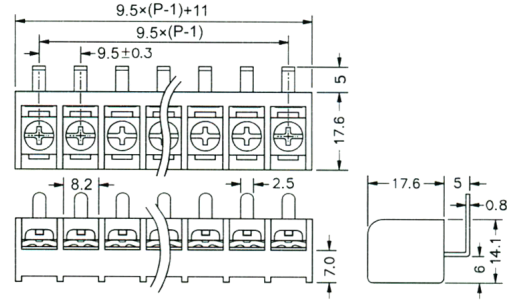
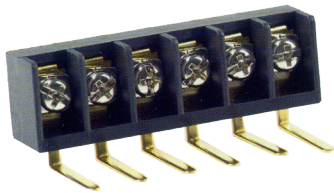

CBP90-05

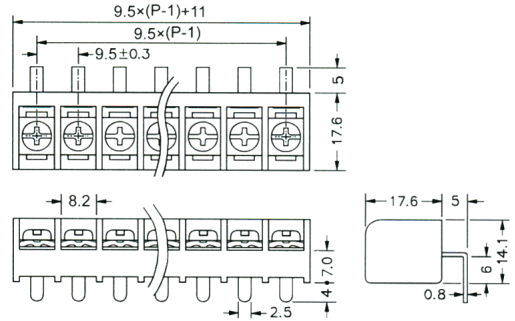
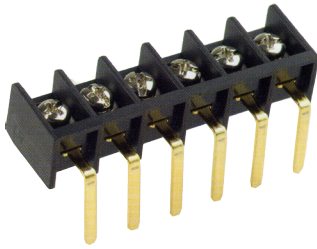

Unit : mm

CBP90-06

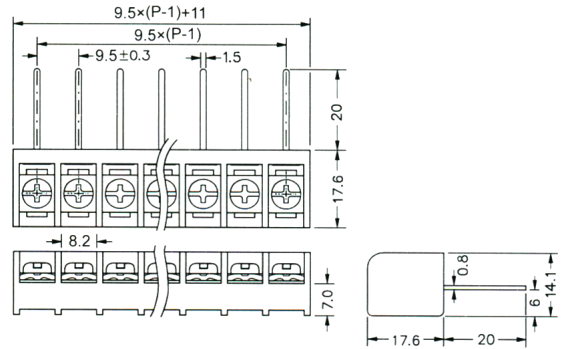
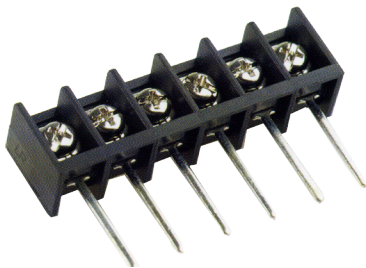

CBP90-07

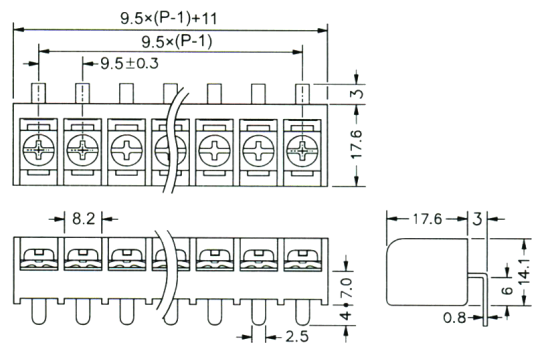
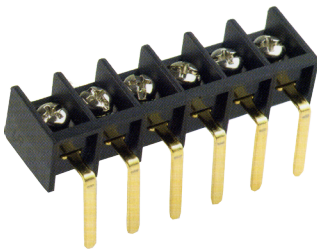

Unit : mm

CBP90-08

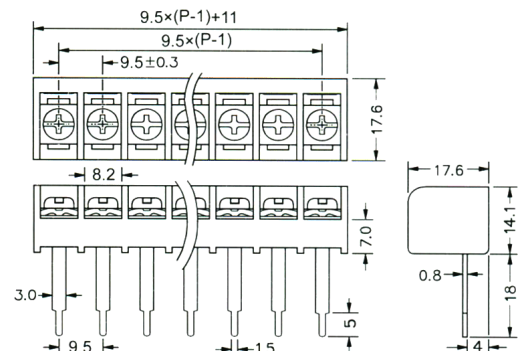
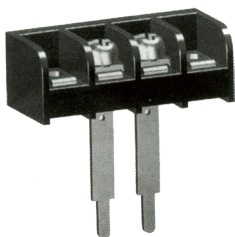

Unit : mm